



**XSTREAM™**  
USER MANUAL 1.5





## Table of Contents

Table of Contents .....	1
Conventions Used in this Guide .....	3
Poseidon XSTREAM.....	5
Approvals/Certifications .....	6
Definitions/Abbreviations .....	7
General safety regulations .....	8
<b>Product descriptions</b>	
Xstream 2:nd Stage .....	10
Xstream 1:st Stage.....	11
Poseidon T.D.A .....	12
Deep / Deep90 1:st Stage (Trimix, Air, Nitrox Ready).....	12
Deco / Oxygen 1:st Stage (Oxygen, Ean, Air) .....	13
Duration/Duration En 144-3 1:st Stage (Ean, Air) .....	14
Dive90 1:St Stage (Air) .....	15
Xstream Lp Hoses.....	15
<b>Usage</b>	
Mounting The Hose .....	16
Pre Dive .....	16
Diving.....	19
After Diveing .....	20
What you do your self.....	21
Accessories .....	22
Diving Gas .....	23
Regulator maintenance service on your regulator.....	24
Product marking.....	24
Other .....	25
Technical data.....	26
Product and Components .....	31
Breathing Performance .....	32
Troubleshooting .....	33
Oxygen Statement.....	35
Annual Service.....	36





## Conventions Used in this Guide

This User's Guide is NOT intended for use as a training manual, or in any way as a substitute for proper training through a legitimate training agency approved by Poseidon AB. It is only intended to provide basic information concerning the Poseidon Xstream.

Throughout this Guide, special alert boxes have been inserted to draw attention to critical information. Three levels of alerts are used in conjunction with color-coded trisymbols, as follows:



### **DANGER:**

Alert boxes that are RED contain extremely critical information related to the safety and well-being of the diver. Failure to comply with information contained in these boxes could lead to serious injury or death.



### **WARNING:**

Alert boxes that are YELLOW contain vital information that may impact a diver's safety and/or proper function of the Poseidon Xstream. Though generally not life-threatening, information contained in these boxes should not be ignored.



### **IMPORTANT:**

Alert boxes that are BLUE contain important information about the proper care and maintenance of the Poseidon Xstream, and that may increase diver comfort or enhance enjoyment during dives.



No part of this book may be reproduced or transmitted in any form or by any means, electronic or mechanical, including photocopying, recording or by any information storage retrieval system, without permission in writing from an authorized representative of Poseidon Diving Systems AB.

Text, photographs and figures copyright © 2024  
by Poseidon Diving Systems AB

ALL RIGHTS RESERVED

**Manual Version 1.5 - February 2024**



### **DANGER:**

Do not attempt to use the Poseidon Xstream without proper training or without a thorough and complete working knowledge of the material contained in this manual. Careless can cause serious injury or death. It is the user's responsibility to attentively monitor the Poseidon Xstream and to have a working knowledge of the procedures if a problem should arise.



## Poseidon XSTREAM

**Welcome, to the world of Poseidon divers. Here at POSEIDON we are very pleased that you have chosen one of the world's foremost diving regulators.**

**POSEIDON has been developing regulators for divers since 1958. Professional divers, military divers, and techdivers choose POSEIDON equipment because of the high demands they place on our products - the same demands you have!**

Your new regulator has been designed to provide you with a life time of pleasure as a POSEIDON diver. Our objective is that the equipment you use should not be noticeable, instead it should be at one with the experience and give you total freedom to achieve what every diver dreams about, the ultimate dive. To be at one with the water. To have full control and at the same time feel the weightlessness when, meter by meter you descent into a world of your own.

Nothing shall disturb your concentration. No wheels or knobs that need adjusting. No regulators that resist your breathing when you have reached your target depth. No suits that limit your freedom of movement or get damaged at the slightest encounter. This vision has accompanied Poseidon since the legendary diving enthusiast and engineer, Ingvar Elfström started the company in the late 50's. The same ideas motivate us now.

The name Poseidon represents constant development and improvement of diving equipment where everything is positioned correctly and everything functions, even in the most extreme situations.

Products developed in cold Scandinavian waters that are among the toughest you can dive in. If they work here, they will work anywhere. Poseidon's devoted followers are convincing proof of that. Thank you for your confidence.

**Yours faithfully**



## Approvals/Certifications

The Xstream regulator series is approved according to PPE Regulation 2016/425 (see Technical Data for full detail).

EN 250:2014 for cold water diving

EN 13949 for oxygen pressure shocks.

CE certificate of conformity  
No. FI21/968950.

SGS Fimko OY,  
Takomotie 8,  
FI-00380 Helsinki,  
Finland  
Notified body number 0598

Production quality assessment  
according to regulation  
Module D is assessed by:

SGS Fimko OY,  
Takomotie 8,  
FI-00380 Helsinki,  
Finland  
Notified body number 0598

Type approval certificate  
GB19/964597 is issued by:

SGS United Kingdom Limited,  
Rossmore Business Park,  
Ellesmere Port,  
Cheshire CH65 3EN, UK  
Approved body number 0120

Production quality assessment  
according to regulation  
Module D is assessed by:

SGS United Kingdom Limited,  
Rossmore Business Park,  
Ellesmere Port,  
Cheshire CH65 3EN, UK  
Approved body number 0120



Poseidon Diving Systems AB is certified according to ISO 9001







## Definitions/Abbreviations

**Oxygen:** any gas mixture containing greater than 21% oxygen up to 99.95% oxygen.

**Trimix:** a gaseous mix containing Oxygen, Nitrogen and Helium.

**EAN 40:** any gas mixture containing greater than 21% oxygen up to 40%. Enriched Air Nitrox.

**IP:** Interstage pressure; the pressure existing between the 1st stage and the 2nd stage valve.

**HP:** High pressure; the pressure inside the SCUBA cylinders, normally ranging between 300 bar (4351 psi) to 10 bar (145 psi)

**Scfm:** standard cubic feet per minute.

**l/min STPD:** standard temperature and pressure dry gas.

**T.D.A:** Thermo Dynamic Anti-Freeze.



## General safety regulations

Although the regulator is functional with pure oxygen and has excellent breathing characteristics down to 50 m (164 ft), the usage is restricted by human limitations, or, by limitations set out by the dive training organisation, whichever is lower.

Poseidon only warrants the regulator performance as specified herein, and cannot be held responsible for improper preparations, incorrect gas mixing and planning, or diving beyond individual medical, psychological and physical limitations.

### Limitations of use:

Xstream Deco, Oxygen and Duration models no higher oxygen content than 99,95% by volume.

Xstream Deep models and octopus only for use with air and a maximum depth of 50 meters.

Maximum depth never more than 50 meters (164 ft), but normally limited by medical effects of the gas.

The oxygen partial pressure must normally not exceed 1.4 bar (20.3 psi), under the foreseeable maximum diving depth. Only if established oxygen exposure tables are strictly adhered to, and a responsible organisation is planning dives with increased exposures, elevated levels can be accepted for a shorter period of time.

The oxygen partial pressure must never be lower than 0.2 bar (2.9 psi), under the foreseeable minimum diving depth.

The nitrogen partial pressure must not exceed 3.2 bar (46.4 psi), under the foreseeable maximum diving depth. Inhaling cold gas and exhaling warmed gas, represents energy losses of the human body (thermal imbalance, hypothermia). This effect increases with increasing depth and can result in a sudden unconsciousness. Diving to extreme depths this effect must be considered, calculated and planned for and preventive actions must be taken, such as proper thermal protection and pre-heated gas.

Xstream is for unlimited use in water temperatures from water freezing temperature tice +4°C to +50°C (122°F). The freezing temperature depends on salt content. Diving with gas blends other than air, or deeper than 18 m (59 ft), or in overhead environment, requires special training regarding practices, equipment, physical and medical understanding.



This manual assumes the reader has some basic knowledge in those respects.

Diving is a strenuous physical activity. Its difficulty may be increased by conditions such as cold water, poor visibility, hard work, and increased depth. Always try to exercise prudent judgement when determining whether or not to dive. Never dive when tired or in poor health.

Do not use gas mixtures containing Helium for dry suit inflation. Helium has very low insulating properties, and contributes to a more rapid cooling of the body. Preferably Argon shall be used, but must never be inhaled. Insulating or actively heating of the body surface has very little effect on the hypothermia described above.

### **WARNING:**

Xstream Oxygen, Xstream Deco and Xstream Duration must be used exclusively with EAN filtered Nitrox or Oxygen and should be kept O2 clean at all times. If an Xstream Oxygen, Deco or Duration regulator is contaminated or used with a contaminated fill then the regulator must be O2 cleaned by a certified Poseidon technician.

### **WARNING:**

The Xstream regulators are not designed to be breathed up on by more than one person at a time. If you configure your Xstream regulator for more than one diver to breathe from it at a time, the cold water performance may not meet minimum safety standards.



## Product descriptions

The Xstream regulator models have been developed based on experience gained from deep-, cave-, wreck- and cold water diving.

The different types of diving all share some common requirements on safety through functionality, simplicity and performance.



### XSTREAM 2:ND STAGE

A number of features greatly improve safety and ease of use:

If debris has degraded the function of the exhalation checkvalve, it can easily be reached and corrected by just twisting off the diffuser. It is the only part which needs to be disassembled, and if it gets lost during the operation, the regulator will continue to function but must only be used for immediate ascent.

Integrated surgical hose fixing points safely secures the regulator to the diver, but in an emergency allows a distressed buddy to retrieve the regulator without undue stress to the diver.

The dead air space is low at just 49.5 ml (3 in3) making CO<sub>2</sub> figures (hypercapnia) minimal. Inhalation resistance is incredibly low and unaffected by depth and breathing pattern. Because of the unique Poseidon valve technology, there is no need for external adjustments.

Xstream is fitted with the new ergonomic mouthpiece Poseidon AIR, with asymmetrical lugs for the most comfortable bite.

All diaphragms are protected so that a strong current or using a scooter or tug does not affect either inhalation or

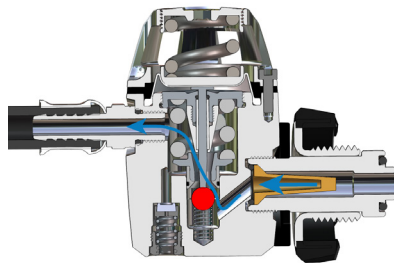
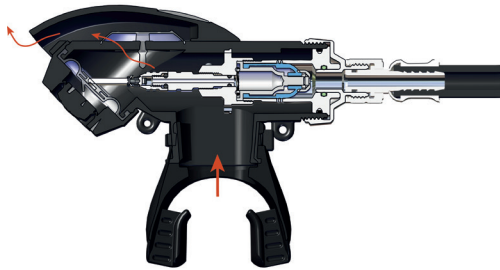
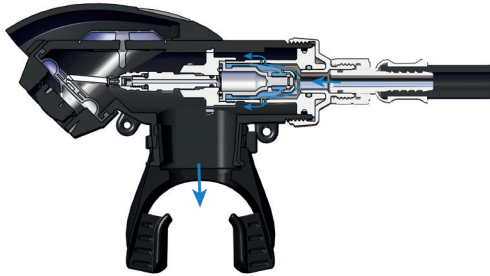

exhalation. A minimal number of moving parts, coupled with thermodynamic engineering, ensures the safe use in an extremely cold environment.

## XSTREAM 1:ST STAGE

In case of a malfunction in the 1st stage causing excessive intermediate pressure, the safety valve integrated in the 1st stage will bleed off the excessive gas. This system both indicates to you that something is wrong so that you can take action, and because of the up-stream servo-valve technique, allows the regulator to continue to breath normally. (conventional downstream regulators are likely to free-flow in such a situation).

The first stage is a balanced rolling diaphragm ball valve producing extreme leak tightness. Conventional designs are sensitive to wear, misalignment, and manufacturing precision. A ball always finds its correct place.

Combined with the 2nd stage, the enormous capacity of the 1st stage make the regulator meet the EN 250 breathing performance requirements even at as low as 16 bar (232 psi) cylinder pressure. This means that you gain an extra 34 bar (493 psi) of gas compared to most other regulators!

The Xstream construction requires less o-rings than any other regulator. Except for sealing the blind screws (3-4), there is just 1 sealing o-ring (semi-static) in the bottommounted versions and 2 in the side mounted.

The hose routing is developed to be optimised for a redundant system, using two regulators. The HP ports are



positioned to accommodate the use of gas monitoring computers Patented e.g. first stage mounted HP sender/receive units.



### POSEIDON T.D.A

Xstream has a built-in Poseidon T.D.A, ThermoDynamic Anti-freeze, which requires no maintenance. It is always there, doing the job. It is thermodynamically protecting the parts which must not freeze.



It is identified by the large slots in the cover, allowing the heat energy of the water to reach the spring. The cold from the inside is consequently insulated from the spring, via an insulation barrier and insulating diaphragm. It is constructed without compromise to any detail to prevent cold reaching the sensitive area. Using Poseidon T.D.A, a regulator can free-flow air in fresh water of 0°C (32°F) for at least 10 minutes and afterwards still be completely unaffected.

### DEEP/DEEP90 1:ST STAGE (TRIMIX, AIR)



All materials in Xstream Deep are chosen and tested to be optimised for Helium and high flow. This requires special attention to leak tightness, since Helium gas has such a low density. All o-rings are of the highest EPDM quality, and rated for use down to -40°C (-40°F) Deep 1st stage comes in two different versions. One side mounted and one bottom mounted. Both versions are certified to 50 m (164 ft) depth, and colour-coded black which in most countries represents a bottom gas mix.



The bottom mounted Deep was discontinued in 2005.

On regulators that have a 6 digit serial number (i.e. 401234) the first digit represents the last number in the manufacturing year. This regulator was manufactured in 2004.

On regulators that have a 7 digit serial number (i.e. 1401234), the first two numbers represents the last two numbers in the manufacturing year. This regulator was manufactured in 2014.

We changed from 6 digit serial numbers to 7 digit serial numbers in 2010.

### **WARNING:**

! Xstream Deep produced before 2015 (serial number starts with 14 or lower) must never be used with an Oxygen content < 21%, or a helium content < 94%.

■ Xstream Deep produced after 2015 (serial number starts with 15 or higher) may be used with an Oxygen content of < 40% (EAN 40 ready) but a helium content < 94%.

### **DECO / OXYGEN 1:ST STAGE (OXYGEN, EAN, AIR)**

O4 stands for oxygen engineered, oxygen compatible, oxygen clean and oxygen approved. Xstream Deco, Duration and Oxygene is O4. It is not just a viton configured air regulator, but in detail engineered for pure oxygen. The Xstream Deco was made as a bottom mounted DIN Connection 1st stage. The connection stem is sealed with a pure copper washer sintered onto the filter.



Production of the Xstream Deco was discontinued in 2005.

It has been tested for 360 bar (5221 psi) adiabatic compression oxygen shocks of less than 20 ms (heated to 60°C/140°F) according to EN 13949. To make the test even more severe than required, it is tested with 99.95% purity of oxygen. Directly from the box, it is cleaned to NASA Specification [1] Cleaning test Level 100 (particle contamination) and NVR levels less than ASTM G63 Level C, <50 mg/m<sup>2</sup> (hydrocarbons).

The Xstream Oxygen 1st stage is only used on the Mk VI and SE7EN Rebreathers.

### **DURATION/DURATION EN 144-3 1:ST STAGE (EAN, AIR)**

Xstream Duration shares the performance and specifications from Deco and Oxygene, but is identified by GREEN colour, and approved for use with gas mixes up to 99,95% oxygen.

The green colour coded Duration is offered for your safety at the dive site and during the dive, avoiding the risk of mixing up regulators for different gasses.

The side mounted Duration model is available in EN 144-3 configuration.

The bottom mounted Duration was discontinued in 2005.







## DIVE90 1:ST STAGE (AIR)

Dive shares the performance and specifications from the other Xstream 90 models. It is identified by the chrome plated T.D.A. top and the number of outlets: 5 low pressure and 2 high pressure.

Xstream Dive is delivered with a 70 cm hose, but all hoses available for the Xstream regulator also fits the Xstream regulator.

The Dive90 was discontinued 2005 and replaced with Deep90.

## XSTREAM LP HOSES

All Xstream hoses are made of high quality SBR/NR, and are available in different lengths. For deep dives or in particularly cold conditions a long hose 2.15m (7 ft) has the benefit of warming the gas by as much as 12°C (22°F) under certain conditions.

Using a long hose requires some basic knowledge in its use and routing, to take the full advantages.

Poseidon does not recommend the use of hose protectors on Poseidon IP hoses. Hose protectors have been shown to mislead the user to neglect the necessary pre-dive hose inspection. Therefore, Poseidon hoses are fitted with wear preventing end crimps, which in addition can be inspected for the full engagement of the hose to the insert at any time through the inspection hole. On Xstream specific hoses (article no 0130-NNN) the hose end at the 2nd stage includes the safety valve. As a visible indication of a fault, the excessive gas will bleed to the ambient environment.



The hose is available in the following lengths as standard

2.15m (7ft.)

1.50m (4.9 ft)

0.90m (3 ft)

0.70m (2.3 ft)



## General safety regulations

### MOUNTING THE HOSE

First time mounting the hose of the length you have chosen, start with unscrewing the blind-screw (5mm allen-key) where you want the 2nd stage. Be careful not to contaminate either the open port or the hose end. Screw the hose in place using a 13mm box spanner. Continue with attaching the 2nd stage. Just screw the nut over the 2nd stage housing, and secure it firmly by hand.



### **OXYGEN ALERT!**

If you have an Oxygen, Deco or Duration model, be absolutely sure not to touch the o-ring or other inner connection areas with your fingers, since grease from your fingers are a combustible contamination.

### PRE DIVE

The procedure described below only describes the manner in which the regulator is assembled, and does not replace all of the various procedures you have learned in your diving training program.

Xstream must always be used with minimum the following SCUBA equipment:

- Compressed gas cylinder(s) conforming to national regulations.
- Frame or holding device for the cylinder(s) with the possibility to mount the harness.



- A safety system, including at least one of the following:
  - A submersible pressure
  - A reserve valve
  - An active low pressure warning device
- 1. Always check the gas-content of the cylinder before attaching the regulator.
- 2. Before attaching the regulator, carefully open the cylinder valve, using gas flow to clear the outlet, then close the valve. Never direct the gasstream to bare skin or clothes (porous materials).
- 3. Remove the protective cap on the first stage. Check that the O-ring on the regulator's connection is intact and clean, then mount the regulator on the cylinder valve. Turn the handwheel/ yoke-knob until you feel that the regulator is securely fastened.



### **OXYGEN ALERT!**

Inspect the o-ring, and make sure it is absolutely free from particles and/or grease. Do not touch the o-ring. Grease and particles can cause a fire.

- 4. Slowly open the cylinder valve all the way, then turn the knob back half turn. When the 2nd stage is pressurised and the servo mechanism engages a maximum of 3 litres of gas vents from the 2nd stage.



## OXYGEN ALERT!

Slow opening of the cylinder valve is the best way to protect the system from compression shocks. Rapid openings represents the highest risk for fire due to compression shock. To ensure a slow opening it is good practice to use both hands, one on top of the other.

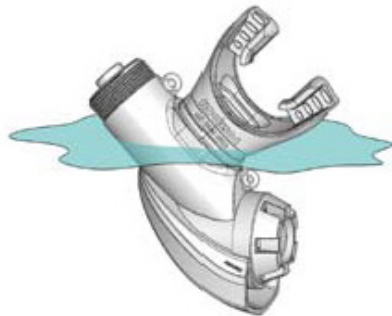
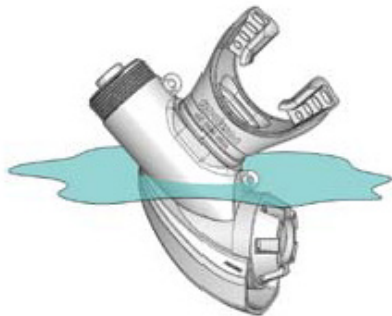

Always open the cylinder, and isolator valves if used, first fully and then a 1/2 turn back.

Partly opened valves increases the pressure drop over the valve and can reduce the performance. On some brands, valves that are almost closed can even shut off during a dive due to internal flexing of materials.

5. Press a few times on the purge button on the second stage so as to blow out possible debris.
6. Check the pressure gauge to see that the tank is full, whilst purging, by watching the almost zero deflection of the needle this indicates that the air is flowing correctly with no restrictions.
7. Test breathe through the regulator and the octopus. If the gas smells or tastes bad do not dive with it.

Tip! You can test the regulator's correct setting by partly immersing the 2nd stage in water, see picture. The servo valve should crack open when the regulator is immersed in between the two positions shown.

Tip! At dives where the water conditions are very cold or there is an apparent risk for hypothermia, i.e. at Trimix dives or water temperatures < 10°C (50°F), it is recommended to use the surgical cord around the neck for the regulator being used. The mouth region can become numb from cold and you risk loosing the regulator.



## Diving

What is most distinctive about the Xstream is that it is easy to use – there aren't any valves or switches to change the flow of gas, reducing breathing performance, etc. You can leave the function and performance of the regulator in our hands and concentrate on what you want to do - dive.



### **OXYGEN ALERT!**

If on any occasion the gas tastes bad, especially the taste of chlorine, always immediately switch to another safe gas source. Bad taste can be a sign of an internal combustion, and lethal gasses can be present.



### **WARNING:**

If on any occasion the safety valve starts bleeding, there is a 1st stage failure. Due to the construction, you can still breathe normally from the regulator. To avoid excessive use of gas, if possible switch to another gas source.  
Ascend, never dive with a malfunctioning unit.



## After Diving

The regulator should always be rinsed while it is still mounted on the tank. The regulator should be under pressure, otherwise water can enter either the first or the second stage and cause the build up of ice during your next dive!

If water enters your first stage, corrosion could form inside the first stage leading to loss in performance and/or failure. If you suspect water has entered the first stage we recommend that you let a service technician, certified to service/repair Poseidon equipment, disassemble your first stage to dry and clean it.

- The regulator should be rinsed in fresh water after every dive so as to avoid salt crystal formation around the functional parts. Purge the second stage while you rinse it, to allow fresh water to access all parts of the second stage.
- Blow the equipment dry by using air pressure.
- After rinsing, close the cylinder valve and purge the regulator.
- Unscrew the regulator from the tank and mount the protective cap onto the connection.
- Pack and store your regulator in your regulator bag. This protects the regulator from damage. It is especially important to protect the connection areas.

The regulator should not be stored in direct sunlight and/or at high temperatures.



### **WARNING:**

Never use the 1st stage housing to unscrew the regulator from the tank. This can fully or partly unscrew the connection stem from the housing, and create a future hazard. Always use the handwheel.



## WHAT YOU DO YOUR SELF

What is most distinctive about the After every dive the equipment should be cleaned according to the instructions in "After diving." The regulator does not have to be lubricated beyond what is done by Poseidon or when serviced.

It is, however, recommended that you regularly lubricate the o-rings located on the low- and high pressure hoses and the first stage "G5/8" or Yoke connection. This will reduce the risk of leakage and prolong the lifetime of the o-rings.

### IMPORTANT

When opening the cylinder valve, do not direct the stream of air at anyone. It can cause serious injury. Always exercise caution with diving equipment. Remember that pressure at 200 bar on a surface the size of a fingernail has the power of approximately 350 kg/770 lb.

Diving is a strenuous physical activity. Its difficulty may be increased by conditions such as cold water, poor visibility, hard work, and increased depth. Always try to exercise prudent judgement when determining whether or not to dive. Never dive when tired or in poor health.



## ACCESSORIES



### OXYGEN ALERT!

All accessories which may be "wetted" by gas containing >21% oxygen must be approved and maintained for oxygen use.



### WARNING:

Notice that EN 250 marked equipment must only be used with air according to EN 12021. Violation can cause a fire and/or the equipment may not function properly.



### WARNING:

The use of accessories which have not been recommended, can seriously impair the function of your equipment. Pressure-gauge hoses without a restriction in the connection can, if the hose is punctured, allow a powerful jet of gas to escape.

Xstream can be combined with the following equipment/accessories, given that the manufacturers' instructions for use are strictly adhered to:

- Xstream EN 144-3 rebuild kit
- Xstream hoses
- Xstream (neck strap) surgical cord
- Poseidon Jetstream 2nd stage and hose, EN 250
- Poseidon Jetstream 1st stage, EN 250
- All CE marked or EN 250 designated cylinder valves
- Yoke clamp
- All CE marked approved pressure-gauge hoses rated for WP 300 bar using UNF 7/16" connection.
- All CE marked pressure gauges, diving computers, and HP transmitters/senders rated for WP 300 bar (4351 psi)
- All CE marked IP-hoses for BCD's and dry-suits. Xstream feeds 7.5-9.5 bar (109-138 psi) to BCD or dry-suit.
- All CE and EN 250 marked mouthpieces.





## DIVING GAS



### WARNING:

Water in the tank is the most common reason for regulator freeze-ups. Inspect your tanks regularly and fill gas only from sources guaranteed to be free from moisture.



### WARNING:

Gas mixing requires special training and knowledge. Poseidon can not be held responsible for an incorrect gas mix. Always follow established calculation methods and mixing procedures for mixing a breathable gas. These are not described herein.



### WARNING:

Xstream Deco, Xstream Oxygen and Xstream Duration must not be used with air complying with EN12021 as this may contaminate the apparatus.

Approved gas mixes for Xstream Deep:

Maximum level of:	
Oxygen	21% by volume
Helium	77% by volume
CO1	5 ppm
CO2	500 ppm
Water dew point	-35°C (-31°F)
Lubricants (droplets/mist)	0.5 mg / m3
Water	25 mg / m3

If air is used it shall be according to EN 12021.



## Regular maintenance service on your regulator

Your regulator is life support equipment and it should regularly undergo maintenance service to minimize the risk of failure, accidents and injury.

We recommend that maintenance service should be performed about once every 100 dives or biannual, whatever comes first. Maintenance service should be performed by a service technician that is certified to service Poseidon equipment and only Poseidon original parts should be used.

It's recommended that you keep a record of the dates when service has been performed, in the Notes section of this user manual, so that you can keep track of when the next service is due.

## Product Markings

Xstream och Xstream Octopus are marked with CE 0120 and EN 250. The markings show that the product meets or exceeds the requirements of PPE Regulation 425/2016 and the harmonized standard EN 250:2014 for SCUBA equipment.



## Other

- A regulator is primarily constructed of brass and recyclable plastic, both of which can be recycled.
- Do not use cleaning chemicals of any kind to clean the regulator. Neither may silicone or any other lubricant be poured or sprayed into the regulator.
- Interstage pressure (IP) and safety valve opening pressure is preset by Poseidon and readjustment is prohibited. Readjustment of IP will never boost performance.
- The use of accessories which have not been recommended can seriously impair the function of your equipment.
- Pressure-gauge hoses without a restriction in the connection can, if the hose is punctured, allow a powerful jet of air to escape.
- Self-made and/or by Poseidon unauthorized changes/modifications to the product may lead to reduced functionality and failure, resulting in personal injury or death. Poseidon are NOT responsible for equipment where modifications beyond product specifications have been made and any/all warranty claims will be turned down.
- Poseidon is NOT responsible for any parts/components manufactured by any party/company other than Poseidon, mounted on Poseidon equipment.



### **WARNING:**

The use of accessories which have not been recommended, can seriously impair the function of your equipment.  
Pressure-gauge hoses without a restriction in the connection can, if the hose is punctured, allow a powerful jet of gas to escape.



## Technical data

Approved gas mixes for Xstream Deco/Duration/Duration90/Oxygen:

Maximum level of:	
Oxygen	99.95% by volume
CO	2 ppm
CO <sub>2</sub>	500 ppm
Water dew point	-45°C (-50°F)
Lubricants (droplets/mist)	0.5mg/ m <sup>3</sup>
Water	25 mg/ m <sup>3</sup>
Gaseous hydrocarbons	15 ppm
Condensed hydrocarbons	0.1 mg/m <sup>3</sup>
Solid particles	2 microns

Approved gas mixes for Dive:

Maximum level of:	
Oxygen	21% by volume
CO	15 ppm
CO <sub>2</sub>	500 ppm
Water dew point	-35°C (-31°F)
Lubricants (droplets/mist)	0.5 mg / m <sup>3</sup>
Water	25 mg / m <sup>3</sup>



Maximum Operational depth	Certified to 50 m (164 ft)	
Typical Work of Breathing 50m on air, 62.5 l/min	1.5 J/l (see diagrams below)	
Typical Work of breathing 200m on Trimix, 62.5 l/min	1.7 J/l (see diagrams below)	
Approved gas	Dive	
	Deep manufactured before 2015	Air
	Duration	Air / EAN 50 / Oxygen
	Deco	Air / Oxygen

Maximum working pressure	300 bar (4351 psi)	
Cold water performance	Exceeding EN 250 requirements for cold water use	
Approvals	Type Approved acc. to PPE Regulation 425/2016	
Applicable Performance Standards	EN 13949, clause 6.6, 6.6.2 EN 250:2014	
Cleaned to hydrocarbon levels < 50mg/ m <sup>2</sup> & particle level X	Dive	No
	Deep	No
	Duration	Yes
	Deco / Oxygen	Yes
O-ring materials	Dive	Nitrile, EPDM
	Deep	Nitrile, EPDM
	Duration	Viton, EPDM
	Deco / Oxygen	Viton, EPDM



<b>Lubricants</b>	Poseidon 1; BAM appr. 270 bar @ 100°C Poseidon 2; BAM appr. 140 bar @ 100°C Poseidon R; silicone oil.	
<b>Colour</b>	<b>Dive</b>	Grey / Yellow
	<b>Deep / Deep90</b>	Black
	<b>Duration</b>	Green
	<b>Deco / Oxygen</b>	White
<b>Warranty</b>	24 months	



<b>2nd stage</b>	
<b>Flow Rate</b>	>2150 l/min STPD (>76 scfm)
<b>Inner Volume</b>	49.5 ml (3 in3)
<b>Weight</b>	152 g (5.4 oz)
<b>Technique</b>	Upstream servo-valve
<b>Safety valve opening pres.</b>	18 +/- 1 bar (261 +/- 14 psi)
<b>Swivelling</b>	Around axis, can be used either side
<b>Material</b>	ASA, Brass, TPU, Silicone, PU
<b>Venturi assist</b>	Automatic
<b>Inhalation control</b>	Automatic
<b>Surgical cord</b>	Silicone
<b>Dismontable w/o tools</b>	Yes
<b>Anatomic Mouthpiece</b>	"Poseidon AIR"



<b>1st stage</b>		
<b>Flowrate (l/min)</b>	>4000 l/min (>141 scfm)	
<b>Nominal inter-stage pres.</b>	8.5 bar (123 psi)	
<b>Anti-Freeze protection</b>	Built in T.D.A	
<b>Technique</b>	Rolling diaphragm	
<b>Valve technique</b>	Ball valve	
<b>Seat material</b>	Zytel	
<b>Test pressure</b>	450 bar (6526 psi)	
<b>Ports</b> <i>** Latest versions</i>	<b>Dive</b>	5 IP (UNF 3/8") / 2 HP (UNF 7/16")
	<b>Deep Duration Deco</b>	3 IP (UNF 3/8") / 1 HP (UNF 7/16")
	<b>Deep 90 Dur. 90 Oxygen</b>	5 IP (UNF 3/8") / 2 HP (UNF 7/16")**
<b>Connection</b> <i>* Only Duration90 manuf. in 2004 or later.</i>	<b>Deep Dive / Dive90</b>	
	<b>Duration/Duration90/ Duration EN 144-3</b>	
	<b>Deco</b>	
<b>Material</b>	Brass, plastics, stainless steel	
<b>Hose</b>		
<b>Standard lengths hose</b>	0.7 m (2.3 ft), 0.9 m (3 ft), 1.6 m (5.2 ft), 2.15 m (7 ft)	

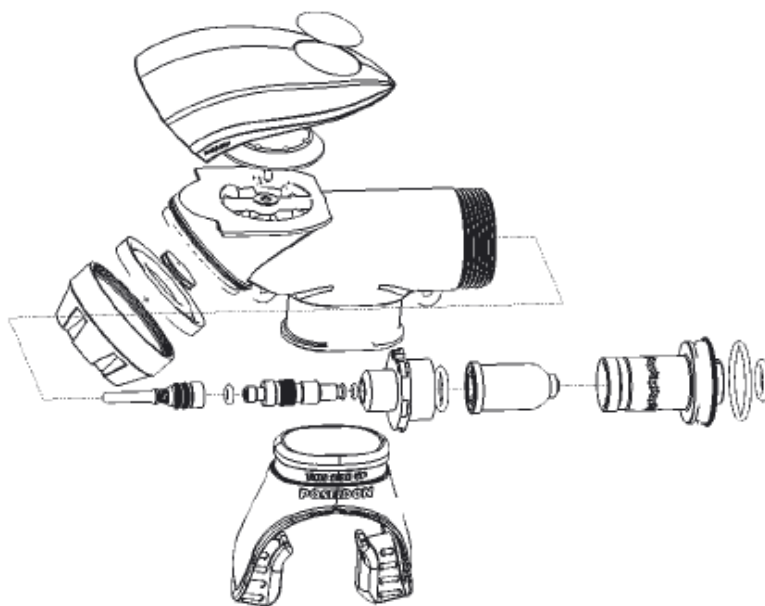
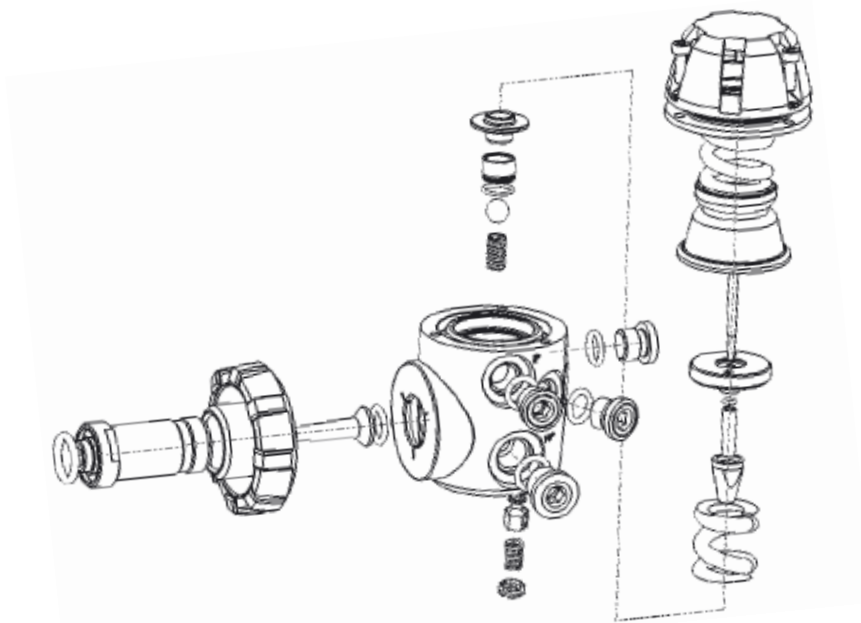





## Product and components

Product	Article Number
<b><u>Breathing Regulator (box marking)</u></b>	
Poseidon Xstream Deep	0100-000
Poseidon Xstream Deep Black	0100-010
Poseidon Xstream Duration	0100-001
Poseidon Xstream Oxygen	0100-002
Poseidon Xstream Octo	0100-003
Poseidon Jetstream	0100-005
<b><u>1st stages (item marking)</u></b>	
Poseidon Xstream Deep	0110-000
Poseidon Xstream Duration M26	0110-001
Poseidon Xstream Duration G5/8	0110-003
Poseidon Xstream Oxygen	0110-002
Poseidon Xstream Deep Black	0110-010
<b><u>2nd stages (item marking)</u></b>	
Poseidon Xstream Deep (with Xstream hose)	0120-000
Poseidon Xstream Duration (with Xstream hose)	0120-001
Poseidon Xstream Oxygen (with Xstream hose)	0120-002
Poseidon Xstream Octopus (with Xstream hose)	0120-003
Poseidon Xstream Black (with Xstream hose)	0120-010
Poseidon Xstream Black Octopus (with Xstream hose)	0120-013
<b><u>Xstream Hoses</u></b>	
Standard hose, length 70cm	0130-000
Standard hose, length 90cm	0130-002
Standard hose, length 110cm	0130-006
Standard hose, length 150cm	0130-008
Standard hose, length 215cm	0130-010
Standard hose, length special	0130-012
Standard hose, length 70cm Black	0130-036
Standard hose, length 90cm Black	0130-037
O2 cleaned Hose, length 70cm	0130-001
O2 cleaned Hose, length 90cm	0130-003
O2 cleaned Hose, length 110cm	0130-007
O2 cleaned Hose, length 150cm	0130-009
O2 cleaned Hose, length 215cm	0130-011
Mouthpiece AIR	4532



## Breathing Performance

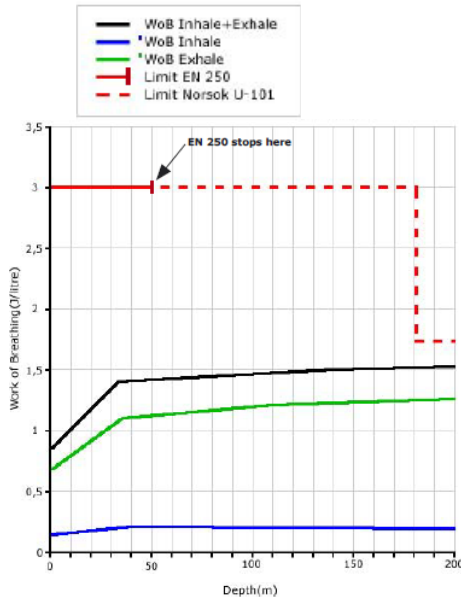

The diagram above show a calculated graph for Work of Breathing in Joules/litre at Qaverage=62.5 litres/min. The equation behind it, is extracted from hundreds of tests, from which coefficients for gas dependency, average flow dependency, and depth dependency is calculated. Its maximum inaccuracy is within +/- 10%. The equation assumes the most dense gas possible to safely breath is used, i.e. a maximum tolerable pO<sub>2</sub>, pN<sub>2</sub> at any depth. Adding more Helium will lower the figures. It is important to understand that this equation does not apply to any other regulator, since the coefficients and characteristics are strongly dependent on the regulator construction.

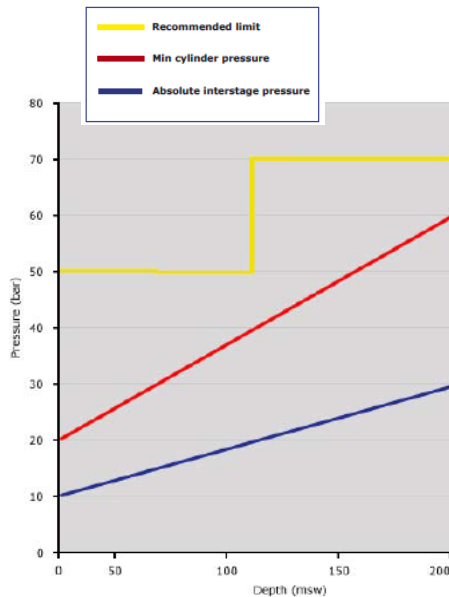

Full regulator capacity is obtained as long as the cylinder pressure is twice the absolute interstage pressure, given the cylinder valve pressure drop is within EN 250 limits. Taking into account the normal variations in interstage pressure and adding a safety margin, the required minimum cylinder pressure during diving is:

50 bar cylinder pressure from 0 msw to 100 msw.

70 bar cylinder pressure from 101 msw to 200 msw

It is a good practise to always plan your dive according to the "1/3-rule", planning to use 2/3 of the cylinder capacity.



## Troubleshooting

Effect	Examine	Reason	Action
Safety valve is opening	Is it spontaneously opening	If yes, it may be a 1st stage error	Terminate dive and have the regulator serviced
Immersed in water, small bubbles are coming from the mouthpiece	Do they stop after the regulator is rinsed	If yes, the valve was probably jammed with salt crystals	Make sure always to rinse the regulator after every dive, using fresh water
	Check the cracking pressure (see section 6.2)	If the cracking pressure is too low, the valve is slightly opened	Have the regulator correctly set by an authorised dealer
	The bubbles remain, cracking pressure is correct	The servo valve is severely jammed by salt crystals	Have the regulator cleaned by an authorised dealer
The regulator free flows breaking the surface	Check the cracking pressure (see section 6.2)	If the cracking pressure is too low, it increases the risk for free-flow	Have the regulator correctly set by an authorised dealer
		If the regulator hits the surface at a certain attitude, it can start a free-flow	Either immerse slowly, keep regulator in your mouth, or hold your hand over the free mouthpiece while entering the water



Leakages at extremely cold conditions		Incorrect orings	Have the regulator serviced by an authorised dealer, require o-ring replacement
There is a sound from the regulator	The sound is occurring even while diving	Incorrect lubricants have been used	Have the regulator correctly lubricated by an authorised dealer
Gas vents from 2nd stage on opening the cylinder valve	Does it stop within 1-2 seconds?	If yes, it is normal that max. 3 litres of air is used to engage the servo-mechanism	
		If no, the cracking pressure is too low, which increases the risk for free-flow	



## Oxygen Statement

In diving operations, the use of oxygen is essential for the human metabolism. In addition, oxygen concentration levels greater than in air, can improve safety, especially but not only, by lowering the risk for DCS and Nitrogen narcosis.

The Poseidon Xstream Deco/Oxygen is approved for use with gaseous oxygen up to 99.95 % purity at maximum 300 bar supply pressure and a maximum gas temperature of 60°C. The Poseidon Xstream Duration90/Duration/Duration EN 144-3 is also approved for use with gaseous oxygen up to 99,95 % purity at maximum 300 bar supply pressure and a maximum gas temperature of 60°C.

Using gaseous mixtures containing oxygen at high pressure always presents a certain level of risk for equipment failure due to combustion. Greater concentration oxygen, greater pressure, greater temperature, respectively represents factors that contributes to increase the mentioned risk. Therefore, Poseidon has taken every precaution using “state of the art” technology, expertise, industrial standards, and knowledge to lower the risk as far as possible. Both Xstream Deco / Oxygen and Xstream Duration are engineered for oxygen use, assembled and cleaned in a clean room environment, made up by materials chosen to expose lowest possible risk x failure-effect product, and are tested and approved for oxygen use.

It is strictly prohibited to use the Poseidon Xstream Oxygen/ Deco/Duration/Duration90 with oxygen (ref. “definitions”) without being fully trained and certified in the use of oxygen by a recognised training agency. Failure to have such training and certification could lead to death or serious personal injury.

It is likewise absolutely essential that the end user strictly follows the mandatory guidelines given in the users manual for the Xstream models. Regular maintenance, servicing and cleaning is a prerequisite for keeping the risk as low as possible. Servicing and cleaning must be carried out by an authorised oxygen service dealer. Poseidon has developed and verified a servicing and cleaning method, which guarantee acceptable levels of contaminations. Poseidon can not be held responsible for the effects of other un-verified cleaning and servicing methods.

Failure to adhere to these mandatory requirements transfers the responsibility to the owner.

Poseidon will continue to develop products and components which further readuses the risks involved with oxygen use. Releasing such products and components is not an admittance that previously released items must be recalled. It is in everyone's interest to always strive for lowering risks.



## Annual Service

It is extremely important for your safety that you keep your equipment in good condition. You need not carry out any other maintenance than described in previous section. The regulator should be serviced annually and this must only be carried out at one of POSEIDON's authorised service locations.



Because of the robustness and simplicity of the Xstream construction, the amount of servicing is kept to a minimum. Service should be done at regular intervals to ensure that the regulator maintains its functionality. It is recommended that you service your Xstream regulator at least once every 24 months as a minimum but preferably once every 12 months or as often as it is estimated to be necessary.

**You can do some fault correcting servicing and/or preventive servicing yourself. Following the instructions which comes with the spare-part, you are allowed to:**

**Replace the diffuser.**

**Replace the mouthpiece.**

**Replace the hose.**

**Modifications of the product are prohibited.**

**Modifications can impair the function of the regulator, and transfers the responsibility to the person who does the modification. Adding decals and other outer means for oxygen/ Nitrox identification, as well as marking with a pen is not regarded as modifications.**



### **WARNING:**

**Do not lubricate the regulator beyond that done by Poseidon or your authorised Poseidon dealer. Spraying lubricants into the 2nd stage can cause deterioration of materials or be a trap for dust particles.**



**Declaration of conformity:**

<https://poseidon.com/docs>

**This PPE protects the user from the following risks:**

- **Drowning**
- **Various nuisance factors**
- **Usage of materials that can affect the human body**
- **Design defects**
- **Incorrect use**

# Poseidon Diving Systems AB

Åkeredsvägen 1, SE-421 63 Västra Frölunda, Sweden

Phone: +46 31 734 29 00

E-mail: [info@poseidon.com](mailto:info@poseidon.com)

[www.poseidon.com](http://www.poseidon.com)

